

RALLYE BRESLAU ***INTERNATIONAL ASSN.***



APPENDIX 5

RALLY SAFETY SYSTEM

Version released on 04.01.2018

1. GENERAL

- 1.1. It is mandatory that each rally vehicle to have properly installed and working “RALLY SAFETY SYSTEM” on board of the racing vehicle.
- 1.2. The system is rented at the administrative check and it is installed and sealed by the organizer at the scrutineering.
- 1.3. The system will be dismantled at the end of the rally or if the competitor is “Out of race” only by a member of the organization. This procedure is done at the” check out control zone”.
- 1.4. The “RALLY SAFETY SYSTEM” consists of the following units:
 - “Tracker box” – 73x73x27mm (WxDxH)
 - “Alarm box” – 40x60x24mm (WxDxH), for Enduro and ATV it is possible to provide an Alarm unit which is mounted on the handle bar without the need of disassembly of other devices.
- 1.5. The devices have built in battery providing back up power if the external power is lost.
- 1.6. The devices have waterproof housing (IP67).
- 1.7. It is forbidden to unseal, disassemble, and remove the external power supply for the devices. Checks will be carried out during the event.

2. FUNCTIONS

- 2.1. The “Tracker box” records the competitor’s progress on the race legs at each second. Additionally it provides real time data to the rally server for live tracking and timing purposes.
- 2.2. The device starts working at the moment the power supply is provided at the scrutineering at the begging of the rally.
- 2.3. The “Alarm button” provides direct transfer of the current coordinates of the vehicle via SMS messaging to the Rally Control for direct alarm signal. Triggering the alarm is done when pressing and holding for over 5 seconds the alarm button. After sending the alarm signal, prepare your mobile phone for communication with Rally Control!

3. TECHNICAL DETAILS:

- 3.1. Dimensions(in mm):

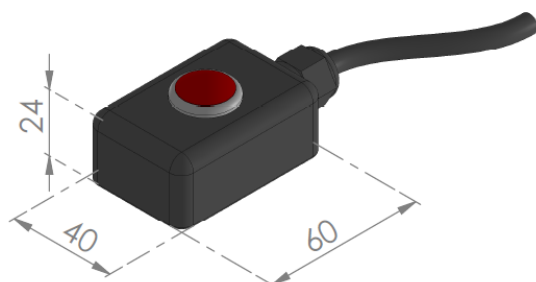

Alarm box (dimensions under change)

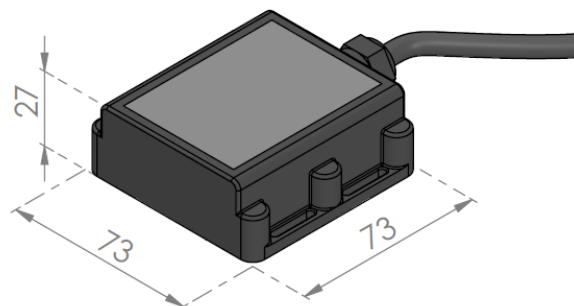

Tracker box

- 3.2. Electrical details:

- The allowed range of voltage is 6V to 30V DC.
- The nominal voltage is 12V.

- Energy consumption (at 12.6V power supply): 110mA r.m.s.
- Maximal power consumption – 2W

4. POWER SUPPLY

4.1. IMPORTANT !!! The battery master cut-off (kill) switch MUST NOT DISCONNECT the power supply for the tracking system.

4.2. It is the responsibility of the competitors alone to provide, DIRECT POWER SUPPLY from the vehicle's battery according to the drawings provided.

4.3. The power cables must be "flexible" (multi wire), insulated cables – 2 x 1.5mm² – RED and BLACK colored.

4.4. The connection may have an IN-LINE FUSE - "BLADE TYPE" of 5A.

VEHICLE'S BATTERY

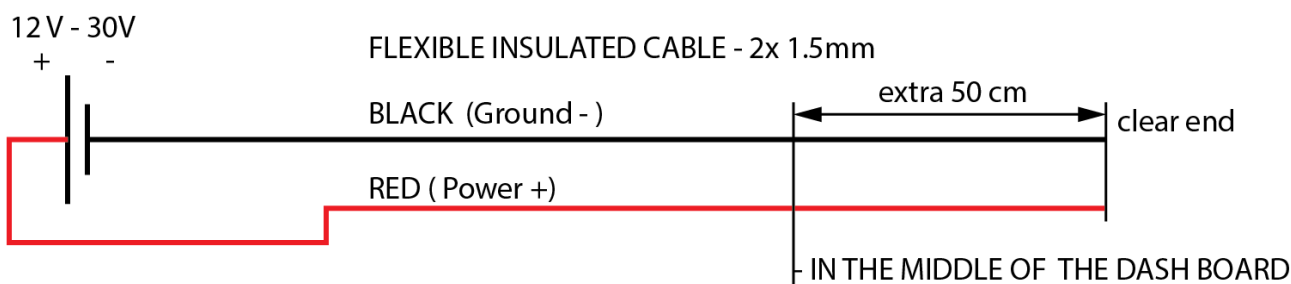

4.5. The wires must be prepared in advance and connected to the vehicle's battery when the vehicle is presented for scrutineering.

4.6. The cable must have minimum 50cm extra usable length from the middle of the dash board (See installation position).

4.7. The connection to the Rally Safety System will be done with a simple connector terminals supplied by the organizer.

5. CONNECTORS

5.1. The power supply cables (Power+ and Ground-) must be equipped with FULLY INSULATED FEMALE Crimp Spade Terminal Connector - 6.3 x 0.8mm.

5.2. See the graphic bellow for example:



6. MOUNTING:

6.1. The mounting of the system will be done by the organizer at the scrutineering.

6.2. The mounting of the alarm box and the tracker box will be according to the specifics of each vehicle using the following (supplied by the organizer):

- Cable / zip ties;
- 3M Velcro tape;
- Electrical connectors

6.3. It is the responsibility of the competitors alone to provide enough space for the Alarm button and the Tracker box in the places shown bellow.

7. INSTALLATION POSITION: ENDURO

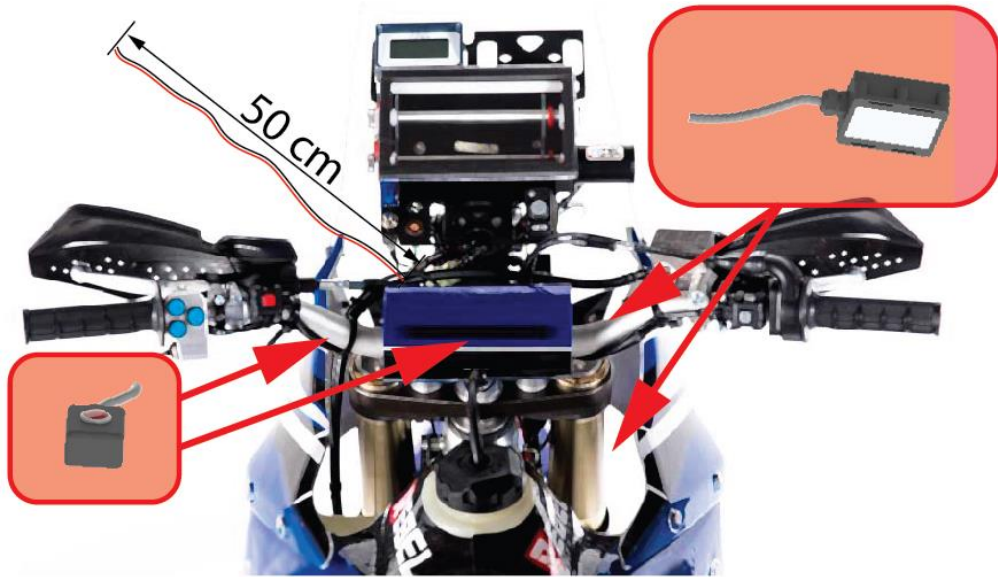

- Extra cable from the middle of the handle bar;
- Alarm box – on the handle bar;
- Tracker box – on the handle bar / Fork / on the side of the instrument panel;

8. INSTALLATION POSITION: ATV

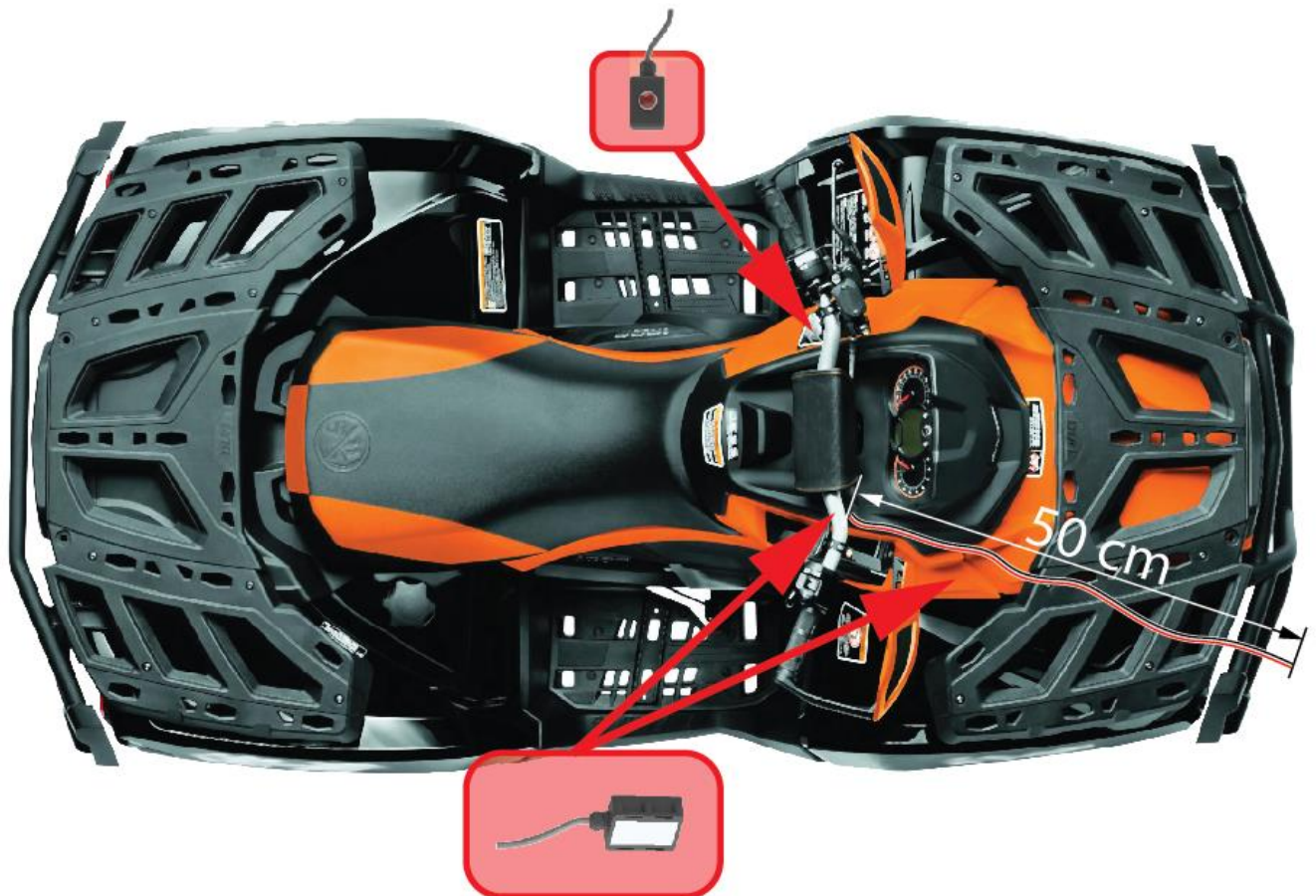

- Extra cable from the middle of the handle bar;
- Alarm box – on the handle bar;
- Tracker box – on the handle bar / on the side of the instrument panel / on the plastic covers;

9. INSTALLATION POSITION: SSV

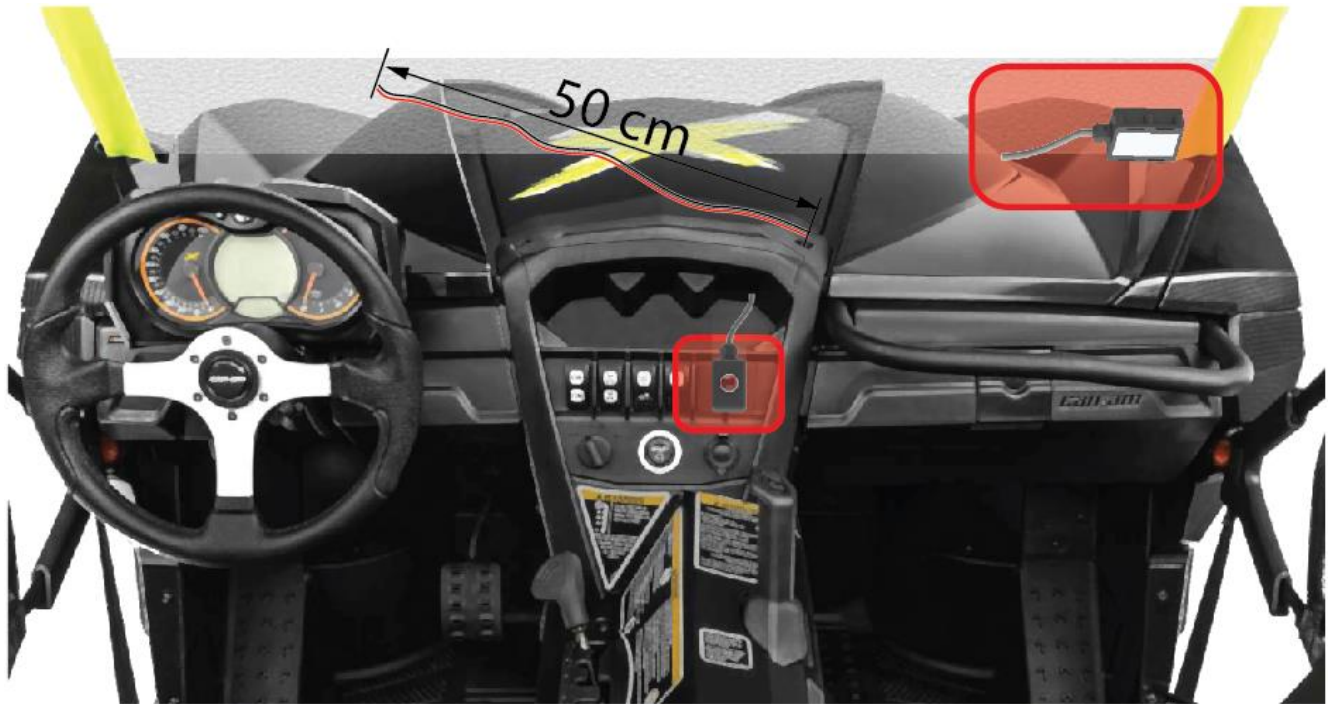

- Extra cable from the middle of the dashboard;
- Alarm box – in the middle of the dashboard / instrument panel, must be reachable by both driver and co-driver;
- Tracker box – on the windscreen inside the cockpit, in front of the co-driver / on the dashboard;

10. INSTALLATION POSITION: CARS

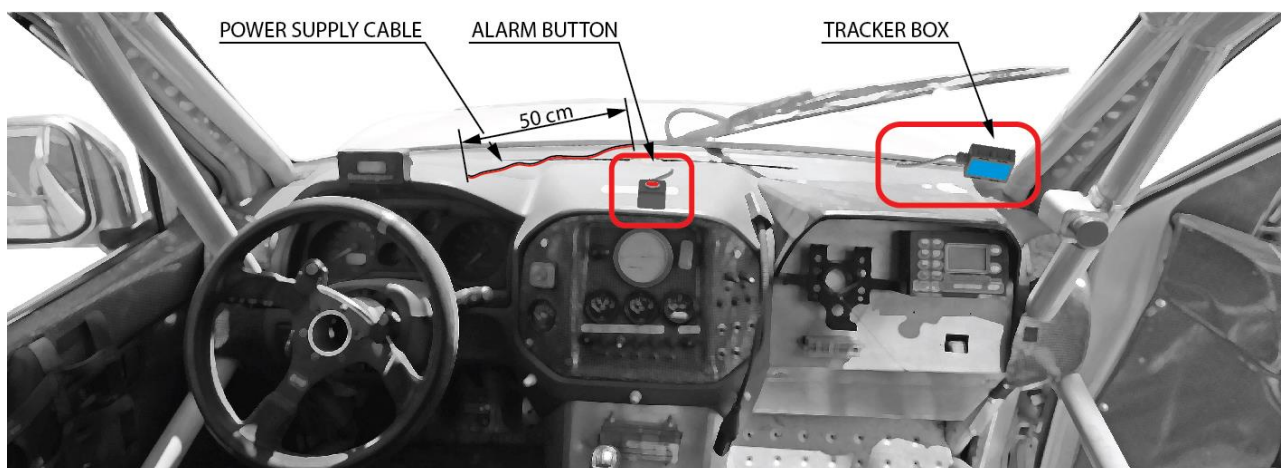

- Extra cable from the middle of the dashboard;
- Alarm box – in the middle of the dashboard, must be reachable by both driver and co-driver;
- Tracker box – on the windscreen inside the cockpit, in front of the co-driver / on the dashboard;

11.INSTALLATION POSITION: TRUCKS



- Extra cable from the middle of the dashboard;
- Alarm box – in the middle of the dashboard, must be reachable by both driver and co-driver;
- Tracker box – on the windscreen inside the cockpit, in front of the co-driver / on the dashboard;